

FOR SEMICONDUCTOR PROTECTION 1100A AR 690V
 SIZE 3 THREAD CONNECTION M12 CARTOUCHE
 FUSIBLE SITOR DE PROTECTION DE SEMI-CONDUCT.



Similar to image

Technical data:

Current / for AC / rated value	A	1,100
Size of the fallback-system / acc. to DIN EN 60269-1		NH3
Supply voltage		
• for AC / rated value	V	690
• for DC	V	440
Switching capacity current		
• in accordance with IEC 60947-2 / rated value	kA	120
Design of an identification indicator		others
Ambient temperature	°C	-20 ... +50
Varying load factor (WL)		1

Certificates/approvals:

General Product Approval

Declaration of Conformity



Further information:

Information- and Downloadcenter (Catalogs, Brochures,...)

<http://www.siemens.com/lowvoltage/catalogs>

Industry Mall (Online ordering system)

<http://www.siemens.com/lowvoltage/maill>

Service&Support (Manuals, Certificates, Characteristics, FAQs,...)

<http://support.automation.siemens.com/WW/view/en/3NC3242-6/all>

Image database (product images, 2D dimension drawings, 3D models, device circuit diagrams, ...)

http://www.automation.siemens.com/bilddb/cax_en.aspx?mlfb=3NC3242-6

CAX-Online-Generator

<http://www.siemens.com/cax>

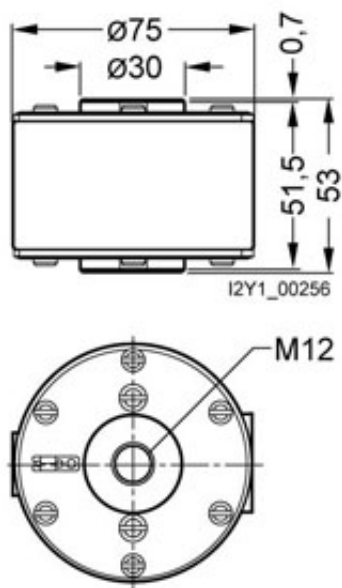

last change:

Feb 15, 2013