



FOR SEMICONDUCTOR PROTECTION 900A AR 1000V
 SIZE 3 CONNECTION CONTACT PLATE 110MM
 CARTOUCHE FUSIBLE SITOR DE PROTECTION DE SEMI-
 CONDUCT.

Similar to image

Technical data:

Current / for AC / rated value	A	900
Size of the fallback-system / acc. to DIN EN 60269-1		NH3
Supply voltage		
• for AC / rated value	V	1,000
• for DC	V	440
Switching capacity current		
• in accordance with IEC 60947-2 / rated value	kA	75
Design of an identification indicator		others
Ambient temperature	°C	-20 ... +50
Varying load factor (WL)		0.9

Certificates/approvals:

General Product Approval

Declaration of Conformity



Further information:

Information- and Downloadcenter (Catalogs, Brochures,...)

<http://www.siemens.com/lowvoltage/catalogs>

Industry Mall (Online ordering system)

<http://www.siemens.com/lowvoltage/maill>

Service&Support (Manuals, Certificates, Characteristics, FAQs,...)

<http://support.automation.siemens.com/WW/view/en/3NC3340-1/all>

Image database (product images, 2D dimension drawings, 3D models, device circuit diagrams, ...)

http://www.automation.siemens.com/bilddb/cax_en.aspx?mlfb=3NC3340-1

CAX-Online-Generator

<http://www.siemens.com/cax>

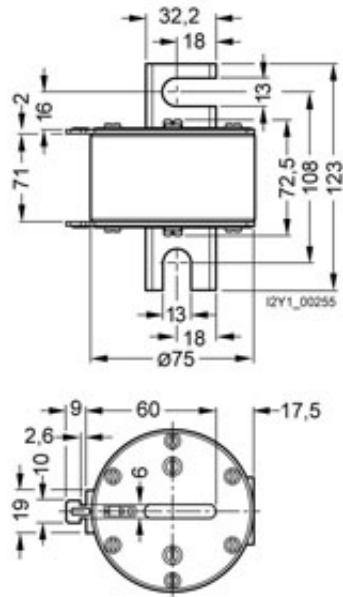

last change:

Feb 15, 2013