



FOR SEMICONDUCTOR PROTECTION 1100A AR 800V  
 SIZE 3 CONNECTION CONTACT PLATE 110MM  
 CARTOUCHE FUSIBLE SITOR DE PROTECTION DE SEMI-  
 CONDUCT.

Similar to image

**Technical data:**

<b>Current / for AC / rated value</b>	A	1,100
<b>Size of the fallback-system / acc. to DIN EN 60269-1</b>		NH3
<b>Supply voltage</b>		
• for AC / rated value	V	800
• for DC	V	440
<b>Switching capacity current</b>		
• in accordance with IEC 60947-2 / rated value	kA	75
<b>Design of an identification indicator</b>		others
<b>Ambient temperature</b>	°C	-20 ... +50
<b>Varying load factor (WL)</b>		0.9

**Certificates/approvals:**

General Product Approval

Declaration of Conformity



**Further information:**

---

**Information- and Downloadcenter (Catalogs, Brochures,...)**

<http://www.siemens.com/lowvoltage/catalogs>

---

**Industry Mall (Online ordering system)**

<http://www.siemens.com/lowvoltage/maill>

---

**Service&Support (Manuals, Certificates, Characteristics, FAQs,...)**

<http://support.automation.siemens.com/WW/view/en/3NC3342-1/all>

---

**Image database (product images, 2D dimension drawings, 3D models, device circuit diagrams, ...)**

[http://www.automation.siemens.com/bilddb/cax\\_en.aspx?mlfb=3NC3342-1](http://www.automation.siemens.com/bilddb/cax_en.aspx?mlfb=3NC3342-1)

---

**CAX-Online-Generator**

<http://www.siemens.com/cax>

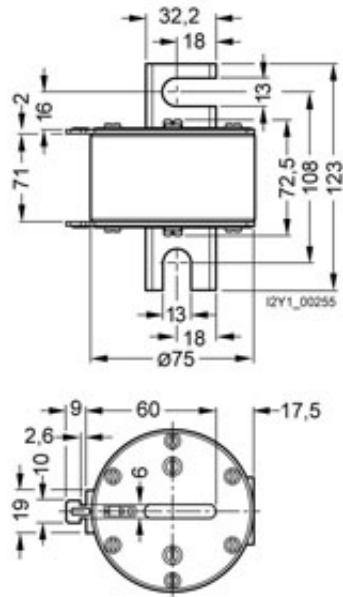

last change:

Feb 15, 2013