



CONTACTOR RELAY, 4NO, AC 230V,
50/60 HZ, SIZE S00, SCREW TERMINAL,
REUSABLE PACKAGE = 144 UNITS

General technical data:

product brand name		SIRIUS
Size of the contactor		S00
Identification number and letter for switching elements		40 E
Product extension / auxiliary switch		Yes
Protection class IP / on the front		IP20
Protection against electrical shock		finger-safe
Degree of pollution		3
Insulation voltage / with degree of pollution 3 / rated value	V	690
Installation altitude / at a height over sea level / maximum	m	2,000
Ambient temperature		
• during storage	°C	-55 ... +80
• during operating	°C	-25 ... +60
Shock resistance		
• at rectangular impulse		
• at AC		7,3g / 5 ms, 4,7g / 10 ms
• at sine pulse		
• at AC		11,4g / 5 ms, 7,3g / 10 ms
Impulse voltage resistance / rated value	kV	6
Mechanical operating cycles as operating time		

• of the contactor / typical	30,000,000
• of the contactor with added auxiliary switch block / typical	10,000,000
• of the contactor with added electronics-compatible auxiliary switch block / typical	10,000,000

Control circuit:

Type of voltage / of the controlled supply voltage		AC
Operating range factor control supply voltage rated value / of the magnet coil		
• at 50 Hz / for AC		0.8 ... 1.1
• at 60 Hz / for AC		0.85 ... 1.1
Apparent pull-in power / of the solenoid / for AC	V·A	37
Apparent holding power / of the solenoid / for AC	V·A	5.7
Inductive power factor		
• with the pull-in power of the coil		0.8
• with the pull-in power of the coil		0.25
Closing delay		
• at AC	ms	8 ... 33
Opening delay		
• at AC	ms	6 ... 25
Arcing time	s	10 ... 15

Auxiliary circuit:

Contact reliability / of the auxiliary contacts		1 faulty switching per 100 million (17 V, 1 mA)
Number of NO contacts / for auxiliary contacts / instantaneous switching		4
[nicht versorgt: PMD_ABP551_001_000]		
•	A	2
• at 690 V	A	1
[nicht versorgt: PMD_ABP553_001_000]		
• [nicht versorgt: PMD_ABP553_001_000]		
•	A	10
•	A	3
•	A	1
• with 2 current paths in series / at DC-12		
• at 24 V / rated value	A	10
• at 60 V / rated value	A	10
• at 110 V / rated value	A	4
• at 220 V / rated value	A	2
• at 440 V / rated value	A	1.3
• at 600 V / rated value	A	0.65

<ul style="list-style-type: none"> • with 3 current paths in series / at DC-12 <ul style="list-style-type: none"> • at 24 V / rated value • at 60 V / rated value • at 110 V / rated value • at 220 V / rated value • at 440 V / rated value • at 600 V / rated value 	A	10
	A	10
	A	10
	A	3.6
	A	2.5
	A	1.8
Operating current		
<ul style="list-style-type: none"> • [nicht versorgt: PMD_ABP558_001_000] <ul style="list-style-type: none"> • • • • with 2 current paths in series / at DC-13 <ul style="list-style-type: none"> • at 24 V / rated value • at 60 V / rated value • at 110 V / rated value • at 220 V / rated value • at 440 V / rated value • at 600 V / rated value • with 3 current paths in series / at DC-13 <ul style="list-style-type: none"> • at 24 V / rated value • at 60 V / rated value • at 110 V / rated value • at 220 V / rated value • at 440 V / rated value • at 600 V / rated value 	A	10
	A	1
	A	0.3
	A	10
	A	3.5
	A	1.3
	A	0.9
	A	0.2
	A	0.1
	A	10
	A	4.7
	A	3
	A	1.2
	A	0.5
	A	0.26
Off-load operating frequency		
<ul style="list-style-type: none"> • at AC • at DC 	1/h	10,000
	1/h	10,000
Frequency of operation		
<ul style="list-style-type: none"> • at AC-12 / maximum • at AC-14 / maximum • at AC-15 / maximum • at DC-12 / maximum • at DC-13 / maximum 	1/h	1,000
	1/h	1,000
	1/h	1,000
	1/h	1,000
	1/h	1,000
	1/h	1,000
Short-circuit:		
Design of the fuse link / for short-circuit protection of the auxiliary switch		
<ul style="list-style-type: none"> • required 		Fuse gL/gG: 10 A, miniature circuit breaker C 6 A (short-circuit current I _k < 400 A)





Installation/mounting/dimensions:

mounting position		+/-180° rotation possible on vertical mounting surface; can be tilted forward and backward by +/- 22.5° on vertical mounting surface
Type of mounting		screw and snap-on mounting onto 35 mm standard mounting rail
Width	mm	45
Height	mm	57.5
Depth	mm	73

Connections:

Design of the electrical connection • for auxiliary and control current circuit		screw-type terminals
Type of the connectable conductor cross-section • for auxiliary contacts • solid • finely stranded • with conductor end processing • for AWG conductors / for auxiliary contacts		2x (0.5 ... 1.5 mm ²), 2x (0.75 ... 2.5 mm ²), 2x 4 mm ² 2x (0.5 ... 1.5 mm ²), 2x (0.75 ... 2.5 mm ²) 2x (20 ... 16), 2x (18 ... 14), 2x 12

Certificates/approvals:

General Product Approval	Functional Safety / Safety of Machinery	Declaration of Conformity
 CCC	 UL Type Examination	 EG-Konf.
 CSA	 GOST	

Test Certificates

[Special Test Certificate](#)

[Type Test Certificates/Test Report](#)

Shipping Approval



Shipping Approval

other



UL/CSA ratings:

Contact rating designation / for auxiliary contacts / according to UL		A600 / Q600
--	--	-------------

Sicherheitsrelevante Kenngrößen:

B10 value / with high demand rate <ul style="list-style-type: none">• according to SN 31920• note		1,000,000 With 0.3 x Ie
T1 value / for proof test interval or service life <ul style="list-style-type: none">• according to IEC 61508	a	20
Proportion of dangerous failures <ul style="list-style-type: none">• with low demand rate / according to SN 31920• with high demand rate / according to SN 31920	% %	40 73
Failure rate (FIT value) / with low demand rate <ul style="list-style-type: none">• according to SN 31920	FIT	100
Product function / positively driven operation to IEC 60947-5-1 <ul style="list-style-type: none">• comment		Yes with 3RH29

Further information:

Information- and Downloadcenter (Catalogs, Brochures,...)

<http://www.siemens.com/industrial-controls/catalogs>

Industry Mall (Online ordering system)

<http://www.siemens.com/industrial-controls/mall>

Cax online generator:

<http://www.siemens.com/cax>

Service&Support (Manuals, Certificates, Characteristics, FAQs,...)

<http://support.automation.siemens.com/WW/view/en/3RH2140-1AP00-ZX95/all>

Image database (product images, 2D dimension drawings, 3D models, device circuit diagrams, ...)

http://www.automation.siemens.com/bilddb/cax_en.aspx?mlfb=3RH2140-1AP00-ZX95

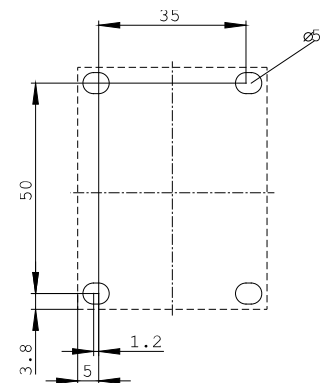
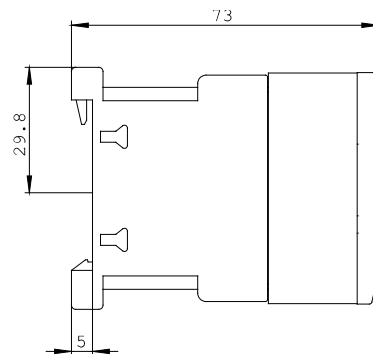
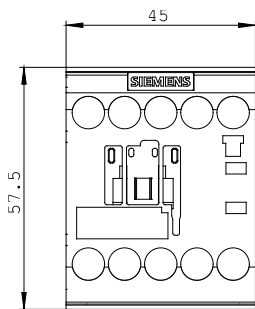

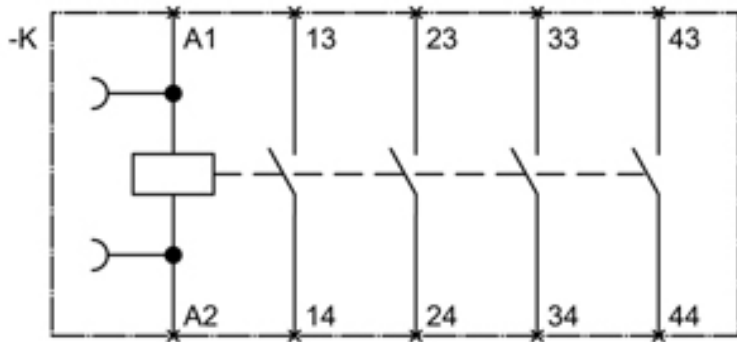

last change:

Feb 15, 2013