

ROTARY DRIVE 400MM BLACK



Similar to image

Technical data:

Design of the operating mechanism		Other
Product equipment / interlock		No
Acceptability for application / emergency stop switch		No
Type from device		other
Design of the electrical connection / for main current circuit		Other
Acceptability for application / safety cut-out switch		No
Type of the driving mechanism / motor drive		No
Protection class IP		Other
Acceptability for application / main switch		No
Acceptability for application / switch disconnecter		No
Product extension / optional / motor drive		No
Product extension / optional / voltage trigger		No
Type of fixing / 4-hole front mounting		No
Type of fixing / central front mounting		No
Suitability for integration / distribution board		No
Acceptability for application / maintenance/repair switch		No

Certificates/approvals:

General Product Approval

other



[Environmental Confirmations](#)

Further information:

Information- and Downloadcenter (Catalogs, Brochures,...)

<http://www.siemens.com/lowvoltage/catalogs>

Industry Mall (Online ordering system)

<http://www.siemens.com/lowvoltage/mall>

Service&Support (Manuals, Certificates, Characteristics, FAQs,...)

<http://support.automation.siemens.com/WW/view/en/5TE9011/all>

Image database (product images, 2D dimension drawings, 3D models, device circuit diagrams, ...)

http://www.automation.siemens.com/bilddb/cax_en.aspx?mlfb=5TE9011

CAX-Online-Generator

<http://www.siemens.com/cax>

Tender specifications

[Datanorm GAEB81](#) [GAEB83](#) [RTF](#) [TXT](#)

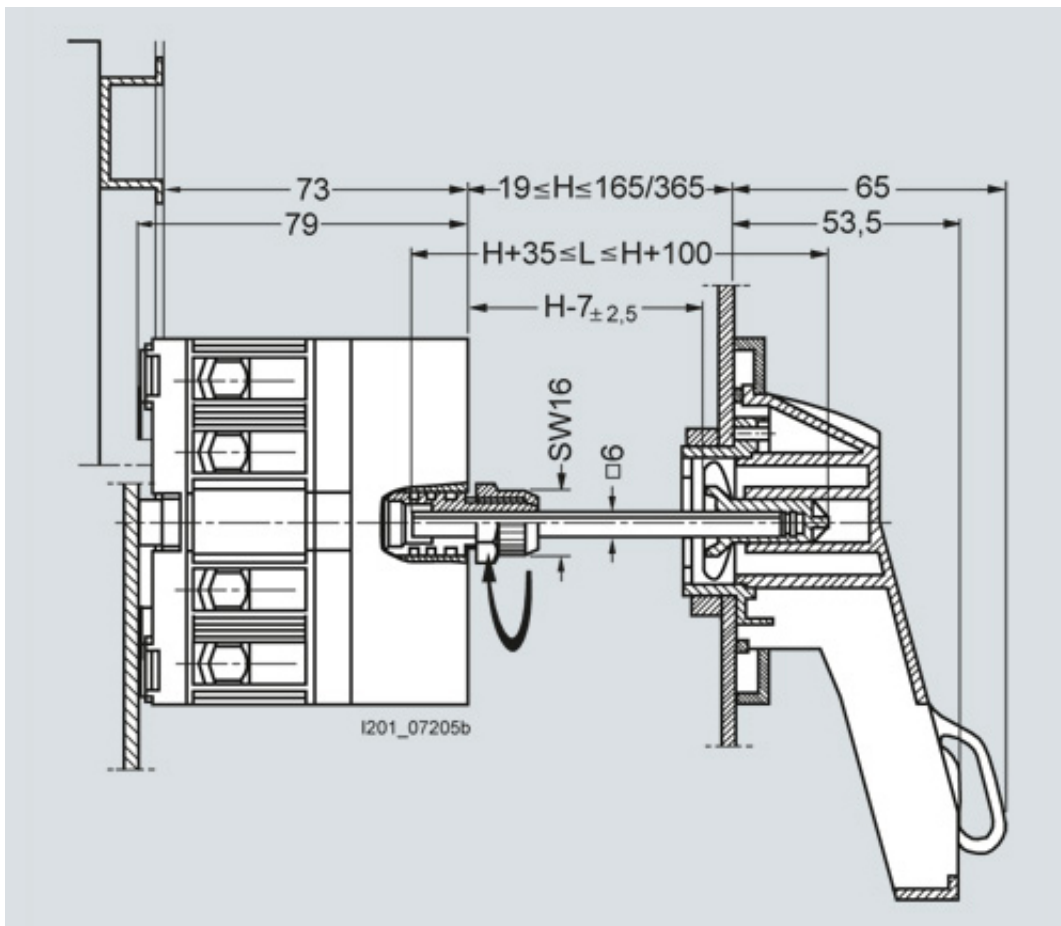

last change:

Nov 5, 2012